

HD-001

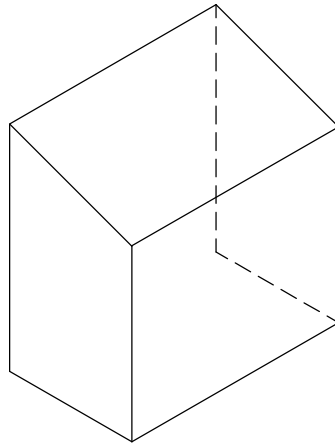

HD-002

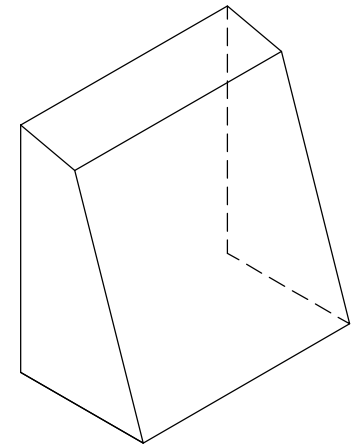

HD-003

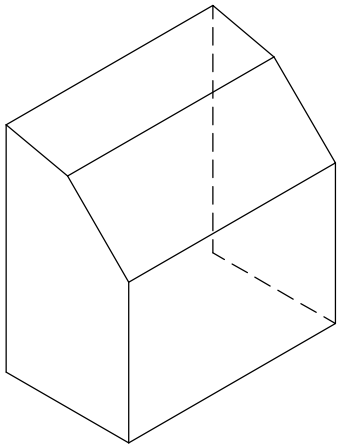

HD-004

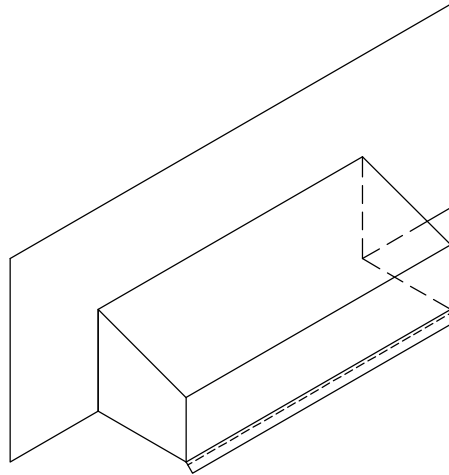

HD-005

**FAST
FLASHINGS**
www.fastflashings.com

Kirkland 425-427-8367 Seattle 206-364-3612

DRAWN BY	DATE	SCALE FACTOR

DRAWING #
HD-LEGEND-01

4D-001 - HD-005

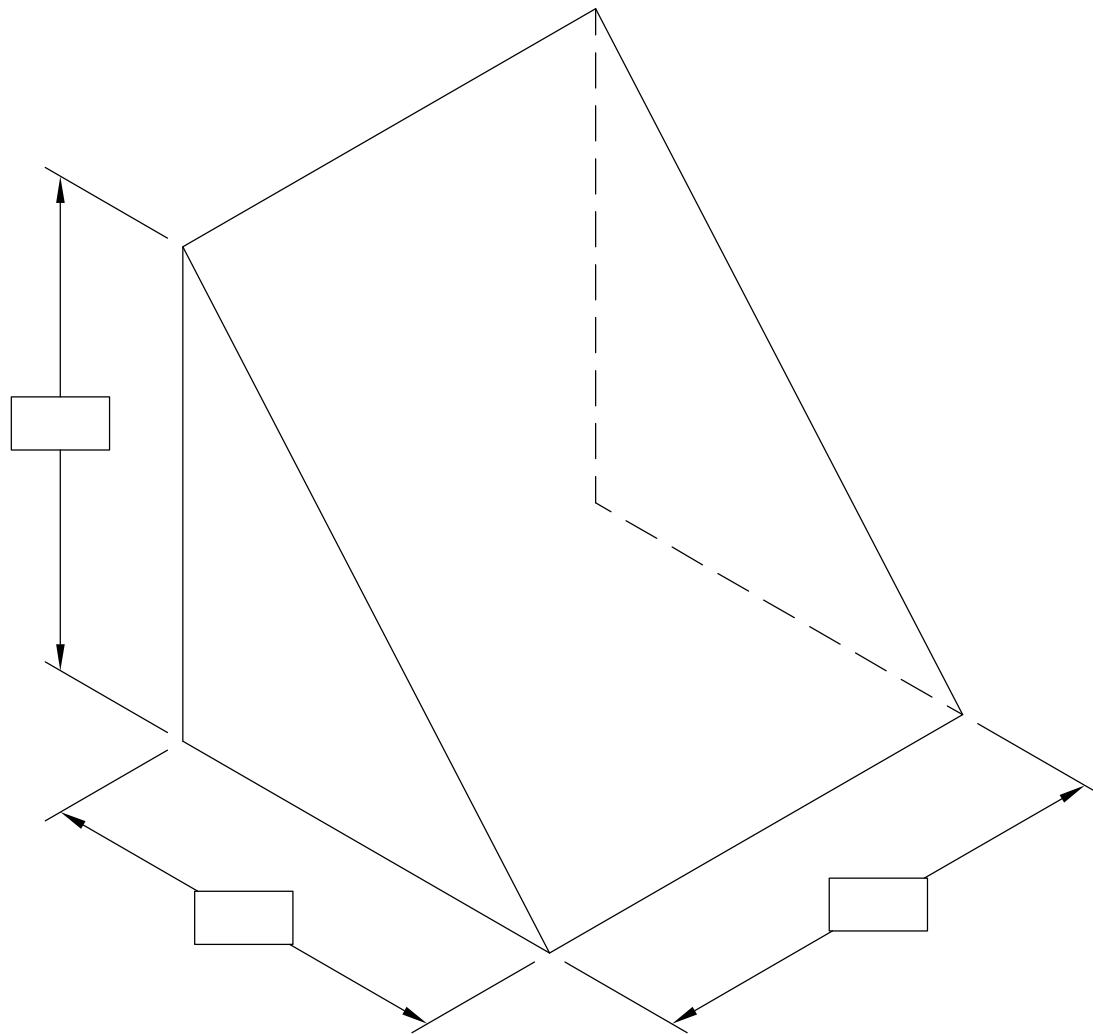

CUSTOMER	
JOB	
ADDRESS	
CONTACT	PHONE
COLOR	
STAINLESS #2 <input type="checkbox"/>	STAINLESS #4 <input type="checkbox"/>
GALVANIZED <input type="checkbox"/>	PRE-PRIMED <input type="checkbox"/>
COPPER 16 OZ. <input type="checkbox"/>	COPPER 20 OZ. <input type="checkbox"/>
GAUGE 22 <input type="checkbox"/>	24 <input type="checkbox"/> 26 <input type="checkbox"/>
QUANTITY	

<i>FAST FLASHINGS</i> <small>www.fastflashings.com</small>		
Kirkland 425-427-8367 Seattle 206-364-3612		
DRAWN BY	DATE	SCALE FACTOR
DRAWING #		
HD-001		

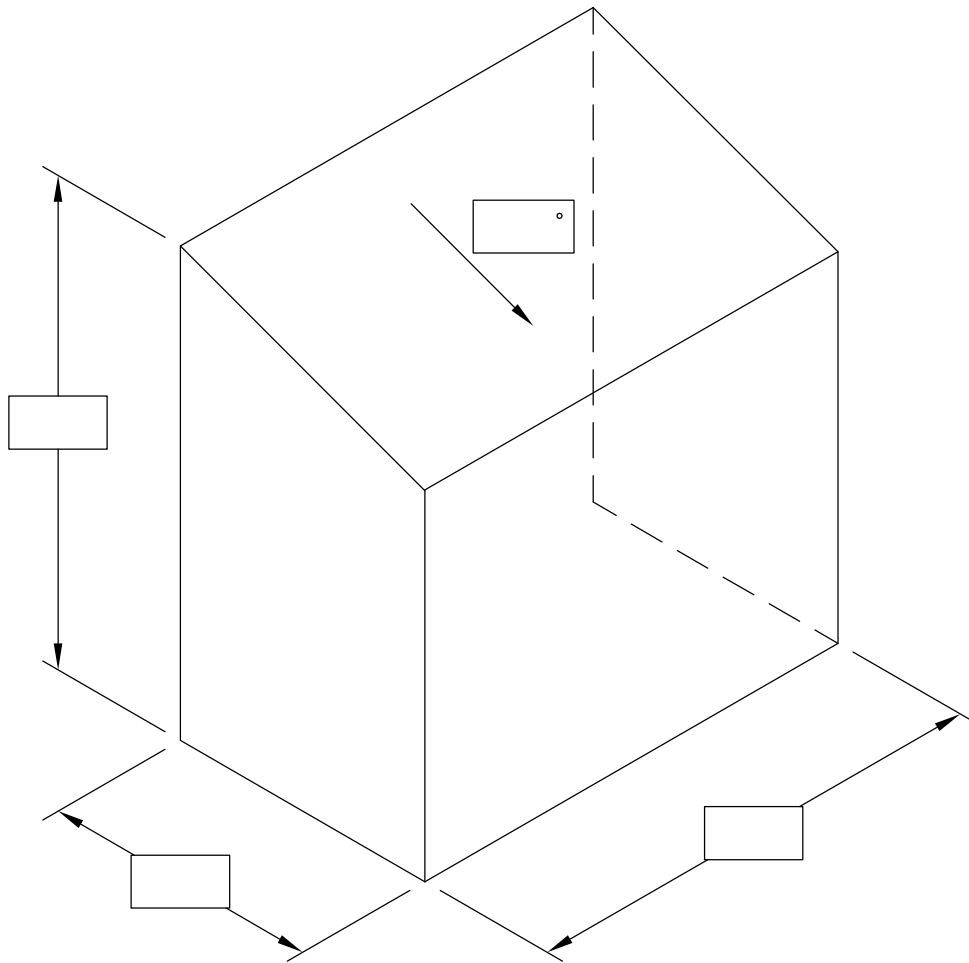

CUSTOMER	
JOB	
ADDRESS	
CONTACT	PHONE
COLOR	
STAINLESS #2 <input type="checkbox"/>	STAINLESS #4 <input type="checkbox"/>
GALVANIZED <input type="checkbox"/>	PRE-PRIMED <input type="checkbox"/>
COPPER 16 OZ. <input type="checkbox"/>	COPPER 20 OZ. <input type="checkbox"/>
GAUGE 22 <input type="checkbox"/>	24 <input type="checkbox"/> 26 <input type="checkbox"/>
QUANTITY	

<i>FAST FLASHINGS</i> <small>www.fastflashings.com</small>		
Kirkland 425-427-8367 Seattle 206-364-3612		
DRAWN BY	DATE	SCALE FACTOR
DRAWING #		
HD-002		

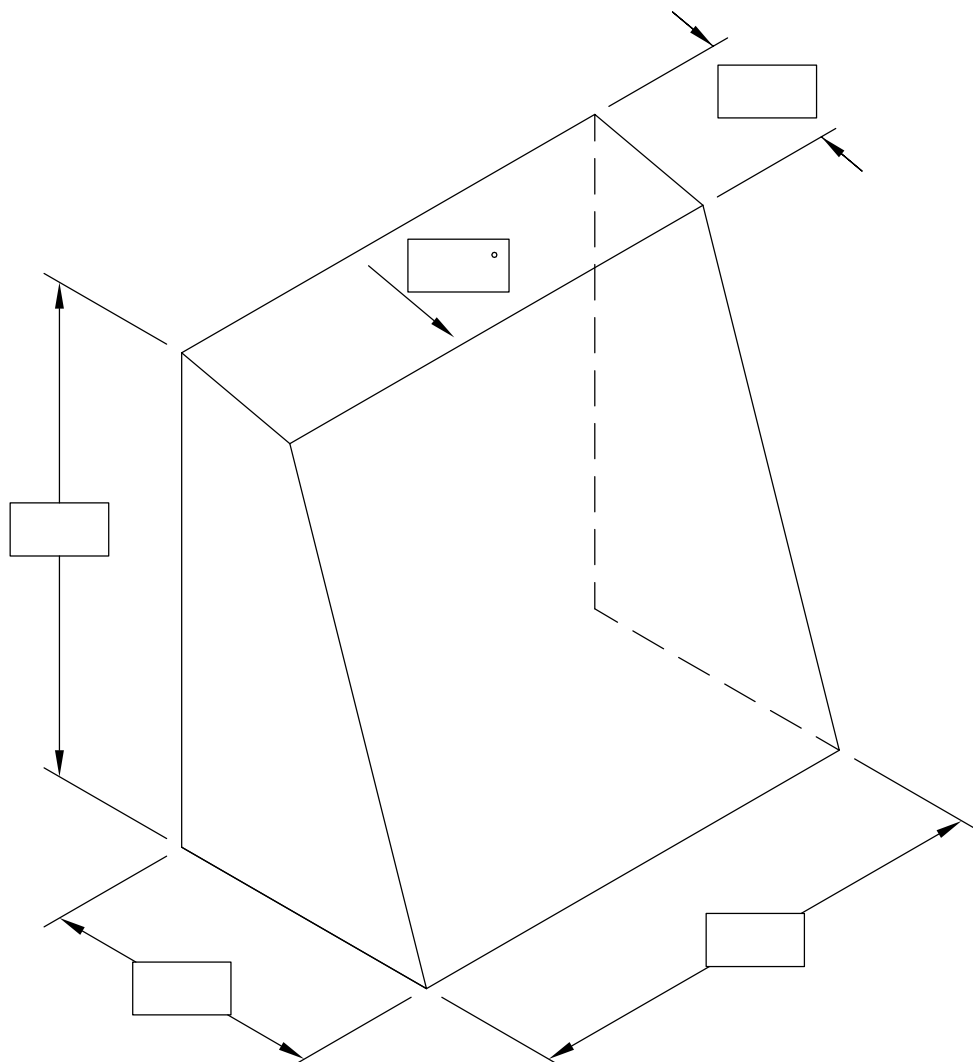

CUSTOMER	
JOB	
ADDRESS	
CONTACT	PHONE
COLOR	
STAINLESS #2 <input type="checkbox"/>	STAINLESS #4 <input type="checkbox"/>
GALVANIZED <input type="checkbox"/>	PRE-PRIMED <input type="checkbox"/>
COPPER 16 OZ. <input type="checkbox"/>	COPPER 20 OZ. <input type="checkbox"/>
GUAGE 22 <input type="checkbox"/>	24 <input type="checkbox"/> 26 <input type="checkbox"/>
QUANTITY	

<i>FAST FLASHINGS</i> <small>www.fastflashings.com</small>		
Kirkland 425-427-8367 Seattle 206-364-3612		
DRAWN BY	DATE	SCALE FACTOR
DRAWING #		
HD-003		

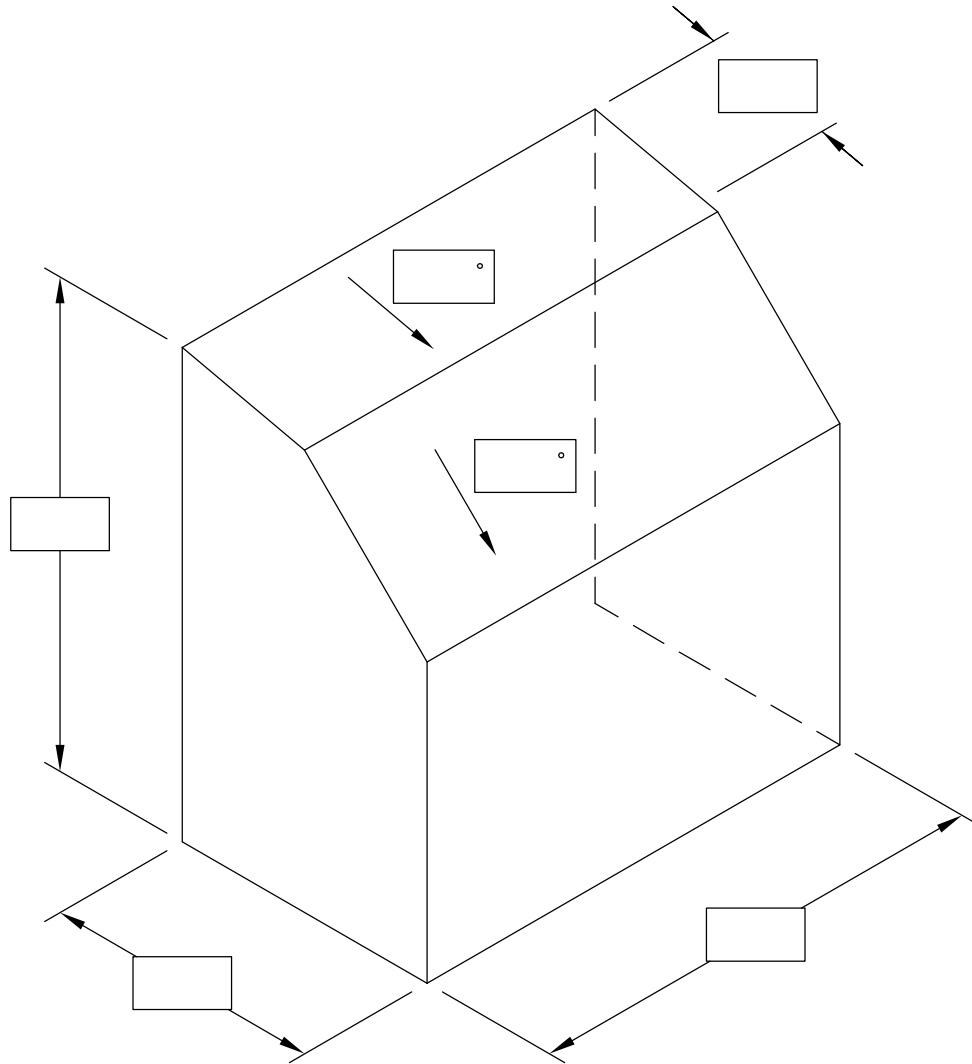

CUSTOMER	
JOB	
ADDRESS	
CONTACT	PHONE
COLOR	
STAINLESS #2 <input type="checkbox"/>	STAINLESS #4 <input type="checkbox"/>
GALVANIZED <input type="checkbox"/>	PRE-PRIMED <input type="checkbox"/>
COPPER 16 OZ. <input type="checkbox"/>	COPPER 20 OZ. <input type="checkbox"/>
GAUGE 22 <input type="checkbox"/>	24 <input type="checkbox"/> 26 <input type="checkbox"/>
QUANTITY	

<i>FAST FLASHINGS</i> <small>www.fastflashings.com</small>		
Kirkland 425-427-8367 Seattle 206-364-3612		
DRAWN BY	DATE	SCALE FACTOR
DRAWING #		
HD-004		

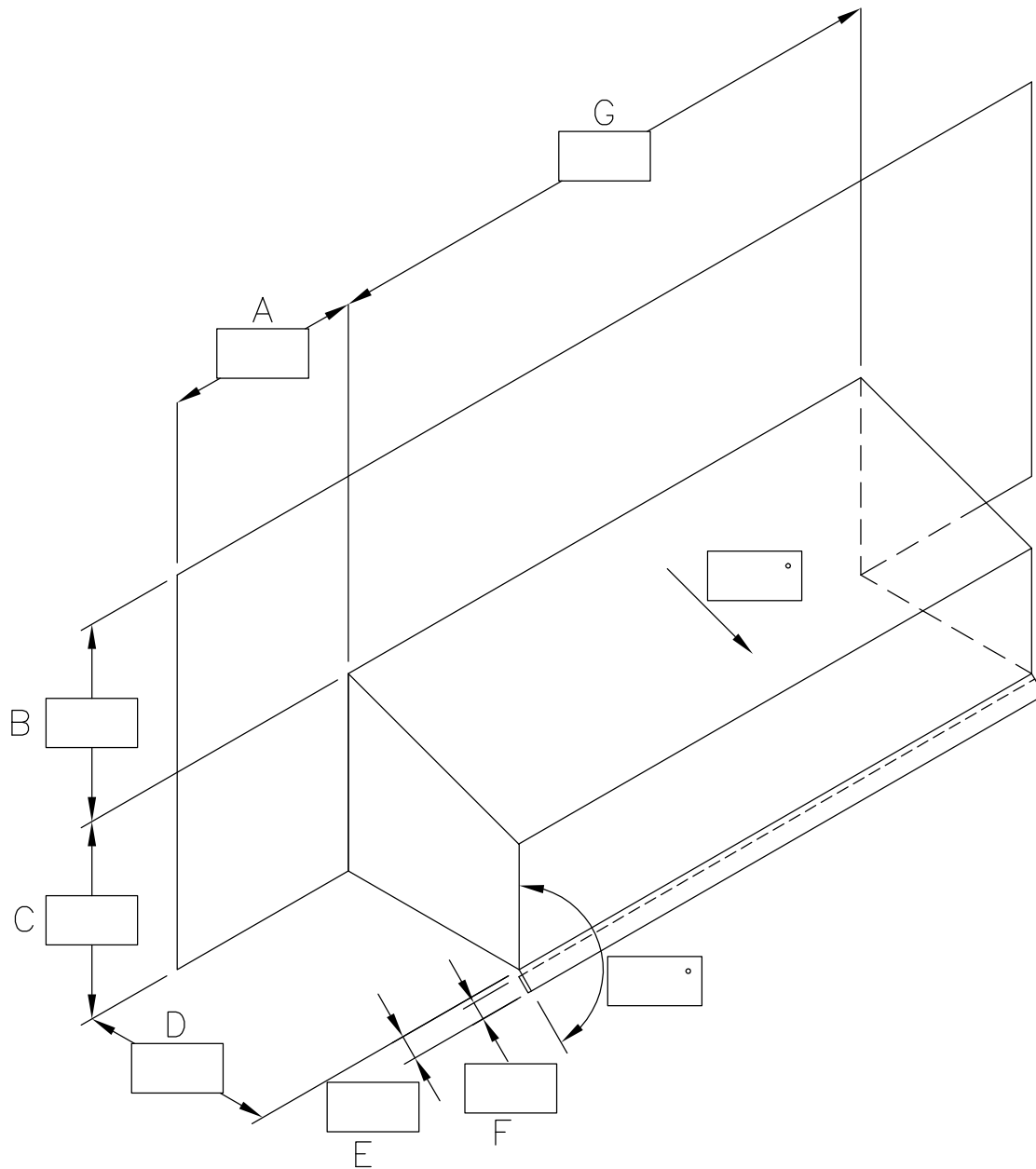

CUSTOMER		
JOB		
ADDRESS		
CONTACT	PHONE	
COLOR		
STAINLESS #2	<input type="checkbox"/>	STAINLESS #4 <input type="checkbox"/>
GALVANIZED	<input type="checkbox"/>	PRE-PRIMED <input type="checkbox"/>
COPPER 16 OZ.	<input type="checkbox"/>	COPPER 20 OZ. <input type="checkbox"/>
GAUGE	22 <input type="checkbox"/>	24 <input type="checkbox"/> 26 <input type="checkbox"/>
QUANTITY		

FAST FLASHINGS
www.fastflashings.com

Kirkland 425-427-8367 Seattle 206-364-3612

DRAWN BY	DATE	SCALE FACTOR
DRAWING #		
HD-005		